

Industrial Motors

Commercial &
Appliance Motors

Automation

Digital &
Systems

Energy

Transmission &
Distribution

Coatings

WG20 GEARED MOTORS

**Gear Units and
Geared Motors**
up to 18,000 Nm



Driving efficiency and sustainability





WG20

A NEW GENERATION of Geared Motors

As one of the leading global manufacturers and solutions providers of drive technology, WEG's aim was to expand its extensive range of products by gear units produced in its own facilities. Perfect coordination of products throughout the drive train has put WEG in a position to offer customers even more superior and efficient solutions.

Under the leadership of WEG Gear Systems (formerly known as Watt Drive Antriebstechnik), the challenge was to develop a program which not only meets the current demands of the market, but also satisfied WEG's high quality requirements. The Group's own centre of excellence for geared motors in Austria, part of the WEG Group since 2011, can draw on more than 50 years of experience in development, production and sales of gear units and geared motors.

In order to satisfy the requirements of state-of-the-art geared motors the following market requirements were taken into account during the development phase:

STANDARD MOUNTING DIMENSIONS

For users, the aim was to make the new range of geared motors as easy and simple to use as possible. To ensure installation in an existing system or production line worked effortlessly without incurring unnecessary costs for conversions, the developers decided to adapt the mounting dimensions of the new gear units to products already established on the market. The objective: worldwide, easy and cost-effective interchangeability.

TORQUE TRANSMISSION

The gear units needed to be compact, efficient, robust and reliable. In order to achieve this goal a transmission had to be designed which allows large ratio ranges in a two-stage model while being able to integrate easily into the new design gear housing.

EFFICIENCY

Energy efficiency has always been of paramount importance to WEG. The aim here was to live up to this demand when designing the new WG20 geared motors. This requires the perfect interaction of sophisticated technology and exclusive use of high quality components.

WORLDWIDE USE

To meet the requirements of global mechanical and plant engineering, it was vital that the new geared motors can be used worldwide, whilst maintaining a high level of flexibility for applications.

The aim was to combine these and other market-related considerations and incorporate them into the designs of the geared motors, which are the perfect addition to WEG's range of products.

The solution is **WG20**.



Features



Highly efficient

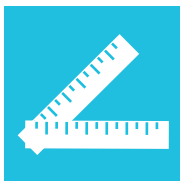

In line with market



Optimised design



Less noise

YOUR REQUIREMENTS - OUR EXPERTISE

WG20 is the first geared motor range to be completely developed in-house at WEG. It comprises helical, parallel shaft, helical bevel and helical worm gear units with torques between 50 and 18,000 Nm. Already the two-stage units excel with their large ratio range, as well as being exceptionally efficient thanks to the sophisticated design. The light aluminium housings of the gear units up to 600 Nm and the robust cast iron housings from 800 Nm provide a highly versatile and reliable product, with a wide range of possible applications.



HIGHLY EFFICIENT

The gear units are two-stage designs featuring a large ratio range, which in turn makes them highly efficient. Furthermore, the products of the WG20 series demonstrate extremely low power losses. On the one hand, this is achieved by low circumferential speeds in the input stage and, on the other hand, by reducing splashing losses due to optimised amounts of lubricant. These characteristics also have a positive effect on the gear lifetime. Under normal conditions of use, the geared motors up to 600 Nm are maintenance-free and lubricated for life.



IN LINE WITH MARKET REQUIREMENTS

For maximum user convenience, the housing of the new gear unit series has been designed in accordance with market requirements. The crucial mounting dimensions of the design correspond with the specifications already established on the market which allows direct interchangability. This means that WG20 geared motors are not only suitable for use in new applications, but can also be easily integrated into existing systems as a replacement or for optimisation purposes.

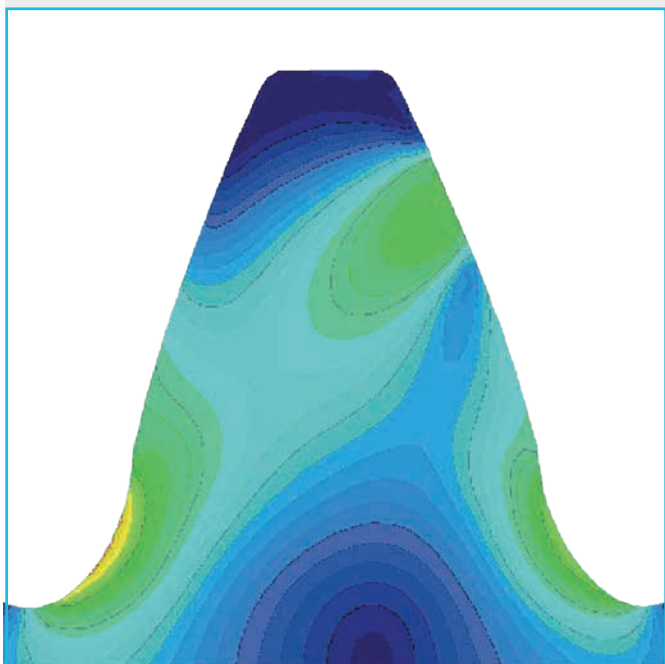

LESS NOISE

The WG20 series gear units are characterised by their smooth, quiet operation. High quality components, which originate almost exclusively from in-house production, engage perfectly to provide the basis for guaranteed low noise operation. Also the flexible gear wheel construction helps reduce noise emission. The small motor pinion causes lower circumferential speeds in the first stage and reduced noise emissions.



OPTIMISED DESIGN

When creating the new gear unit range, the designers paid particular attention to develop a robust housing, opting for a light aluminium construction for the frame sizes up to 600 Nm. The die casting process used in production not only benefits from a smooth surface for demanding hygienic applications, but also features excellent heat conductivity. The housing design additionally enhances this property. The intelligently designed surface encourages heat dissipation from the internal gear parts, thereby aiding more efficient operation and a longer life.

The housings for frame sizes from 800 Nm are fabricated in MONOBLOC design and made of cast iron, making them especially sturdy and torsionally stiff.

Gear teeth geometry has also been refined. Calculations applying the finite element method have optimised gear teeth safety, especially in the tooth base area. High quality standards in the gear wheel production process not only ensure a sound and smooth operation, but also increased durability.

The overall compact design also affects the amount of lubricant used, helping to conserve resources when handling raw materials. Due to the arrangement of gearing units and optimised housing interior, only low levels of oil are necessary in the gear unit.

WEG has also achieved improvements on the input side. The end shields and terminal box of motors up to frame size 132 are now made of light aluminium which considerably reduces the weight of the geared motor. For frame sizes 160 up to 280 cast iron motors are used which are based on the latest W22 motor technology.

Furthermore, the terminal box dimensions have been changed for easier access.

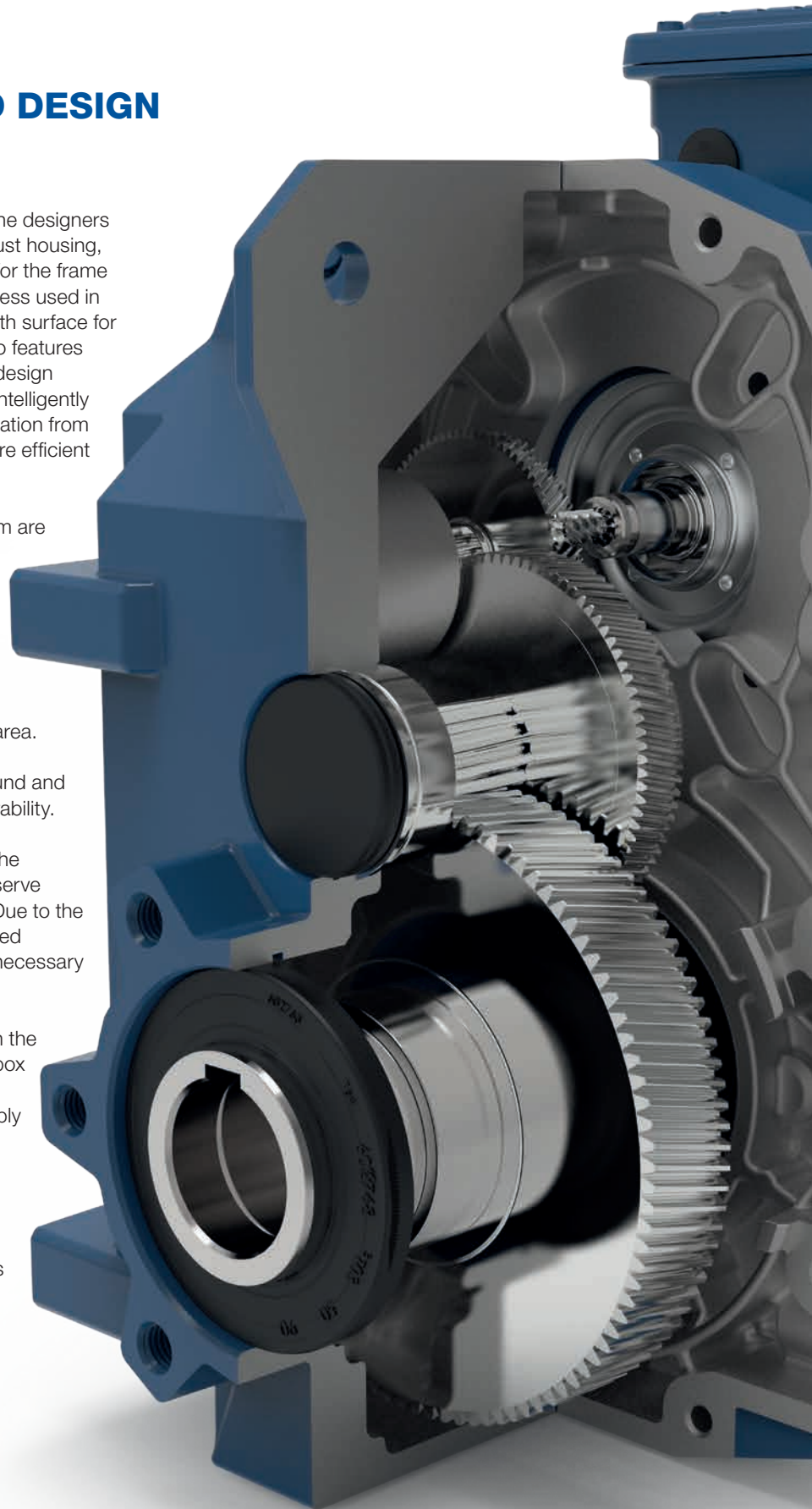

Helical geared motors C

The helical gear units come in twelve housing sizes for nominal torques from 50 to 18,000 Nm and are available in both foot and flange designs. While the two smaller gear units (C00 and C01) are able to perform to their full potential with just two stages, the larger sizes C03 to C08 are available in both two or three stages for applications in higher torque ranges. From size C09 there is an additional fourth stage, while the C16 is even equipped with 5 gear stages.

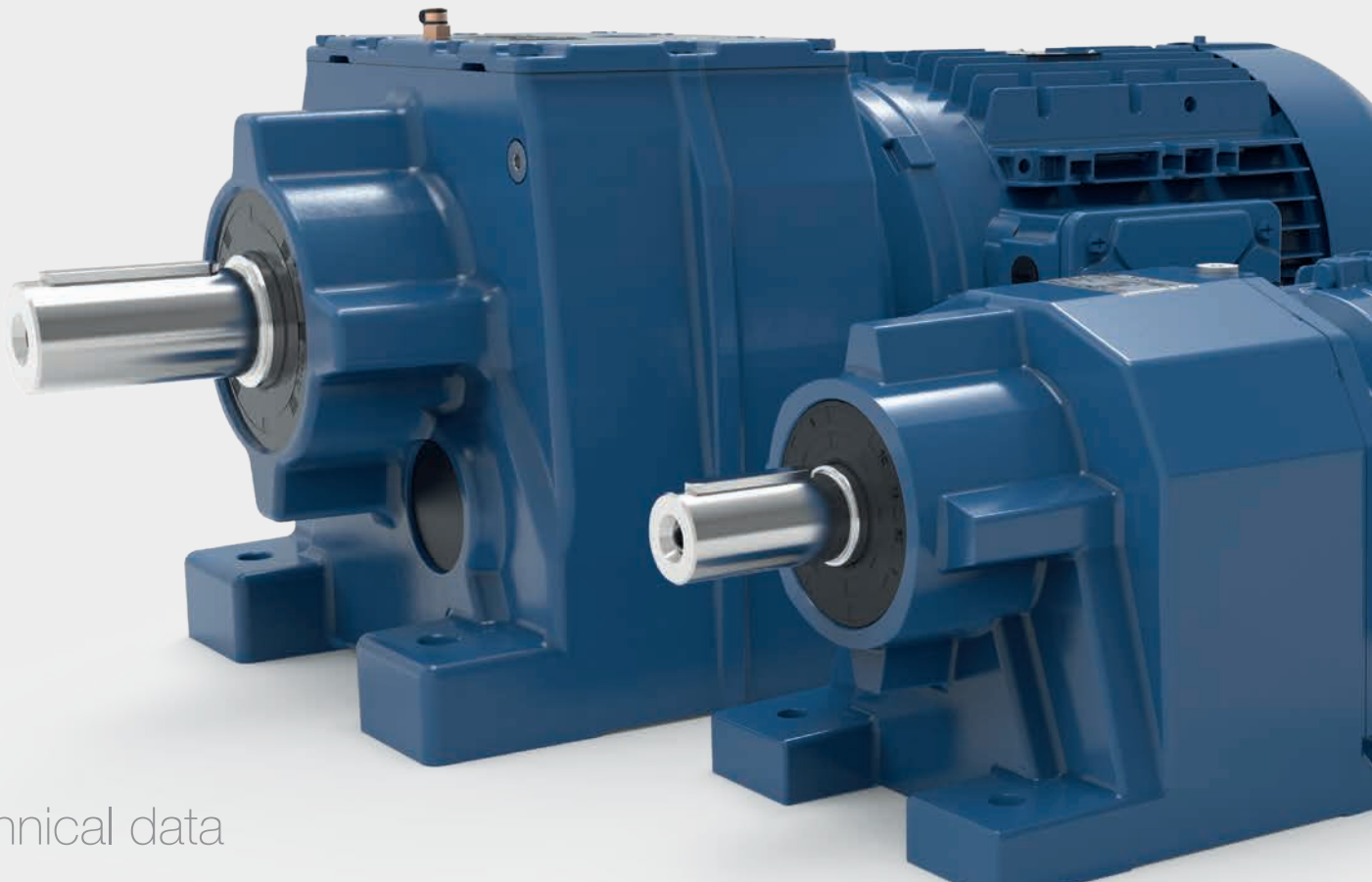

Technical data

	Nominal torque [Nm]	Number of stages	Ratio range	Speed range at 1400 rpm 50 Hz [rpm]	Power range 50Hz [kW]	Output shaft [mm]	Output flange IEC [mm]	Housing material
C00	50	2	2.44 - 47.44	29 - 573	0.12 - 0.75	20 x 40	120/140/160	Aluminium
C01	85	2	3.09 - 66.50	21 - 453	0.12 - 1.5	20 x 40	120/140/160	
C03	200	2 / 3	3.34 - 286.32	4 - 419	0.12 - 3	25 x 50	120/140/160/200	
C05	400	2 / 3	3.69 - 328.43	4 - 366	0.12 - 7.5	30 x 60 35 x 70	160/200/250	
C06	600	2 / 3	3.73 - 375.71	3 - 376	0.12 - 9.2	35 x 70	200/250	
C07	820	2 / 3	5.30 - 351.33	4 - 264	0.12 - 15	40 x 80	250/300	
C08	1550	2 / 3	5.12 - 368.94	4 - 274	0.12 - 22	50 x 100	300/350	
C09	3000	2 / 3 / 4	4.22 - 3282.02	0.4 - 332	0.12 - 30	60 x 120	350/450	
C10	4500	2 / 3 / 4	4.19 - 2636.78	0.5 - 334	0.12 - 37	70 x 140	350/450	
C13	8000	2 / 3 / 4	4.00 - 1891.77	0.7 - 350	0.12 - 75	90 x 170	450/550	
C14	13000	2 / 3 / 4	5.17 - 2162.84	0.7 - 271	0.12 - 90	110 x 210	450/550	
C16	18000	2 / 3 / 4 / 5	5.96 - 22405.25	0.1 - 235	0.12 - 110	120 x 210	550/660	

Design versions

Foot

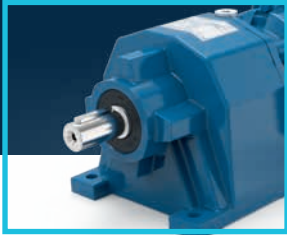

Flange



Standard mounting dimensions

Taking the most significant standard mounting dimensions available into account, the design allows for easy integration of WG20 geared motors into almost any existing systems.

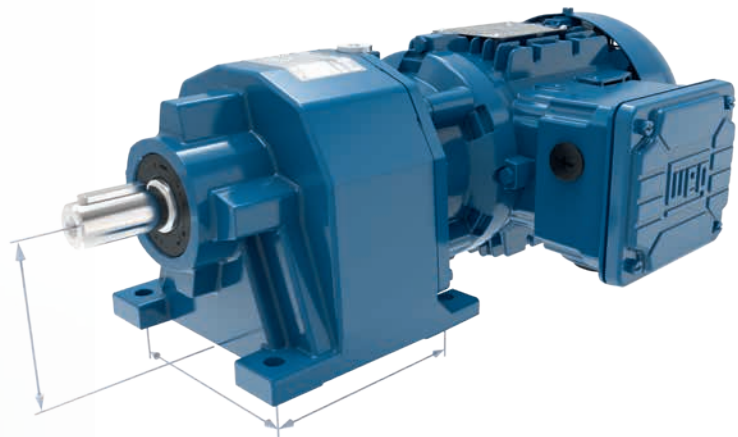

Typical areas of application

Machines for timber processing companies, presses, conveyor belts, rotary tables, pumps, packaging machines, bakery equipment, lifts, looms, screw conveyors and screw compressors.

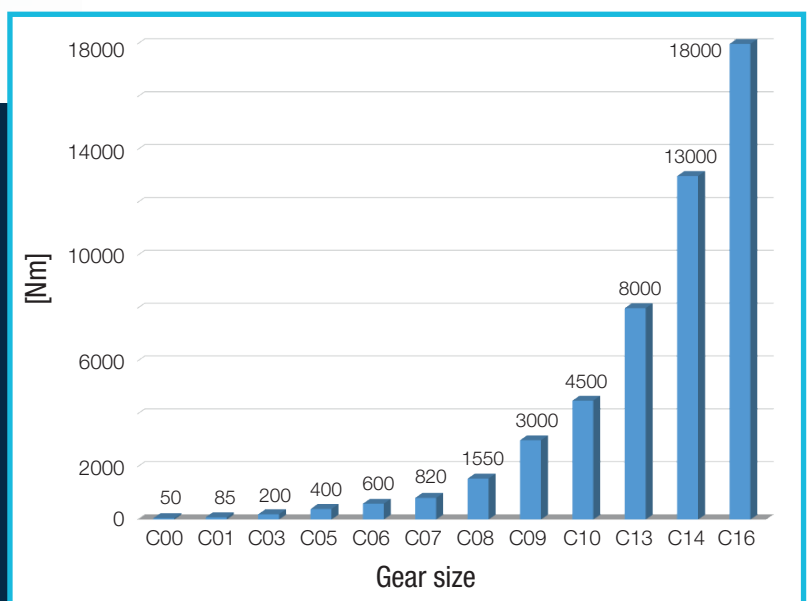

Parallel shaft geared motors F

Thanks to their structural design, parallel shaft gear units are particularly suitable for conveyor technology applications. All 11 sizes can be fitted with either a hollow shaft, output shaft, mounting flange or shrink disc. The ratio range of gear unit sizes F04 to F07 can be extended by a third, from size F08 by a fourth and at size F15 even with a fifth gear stage.

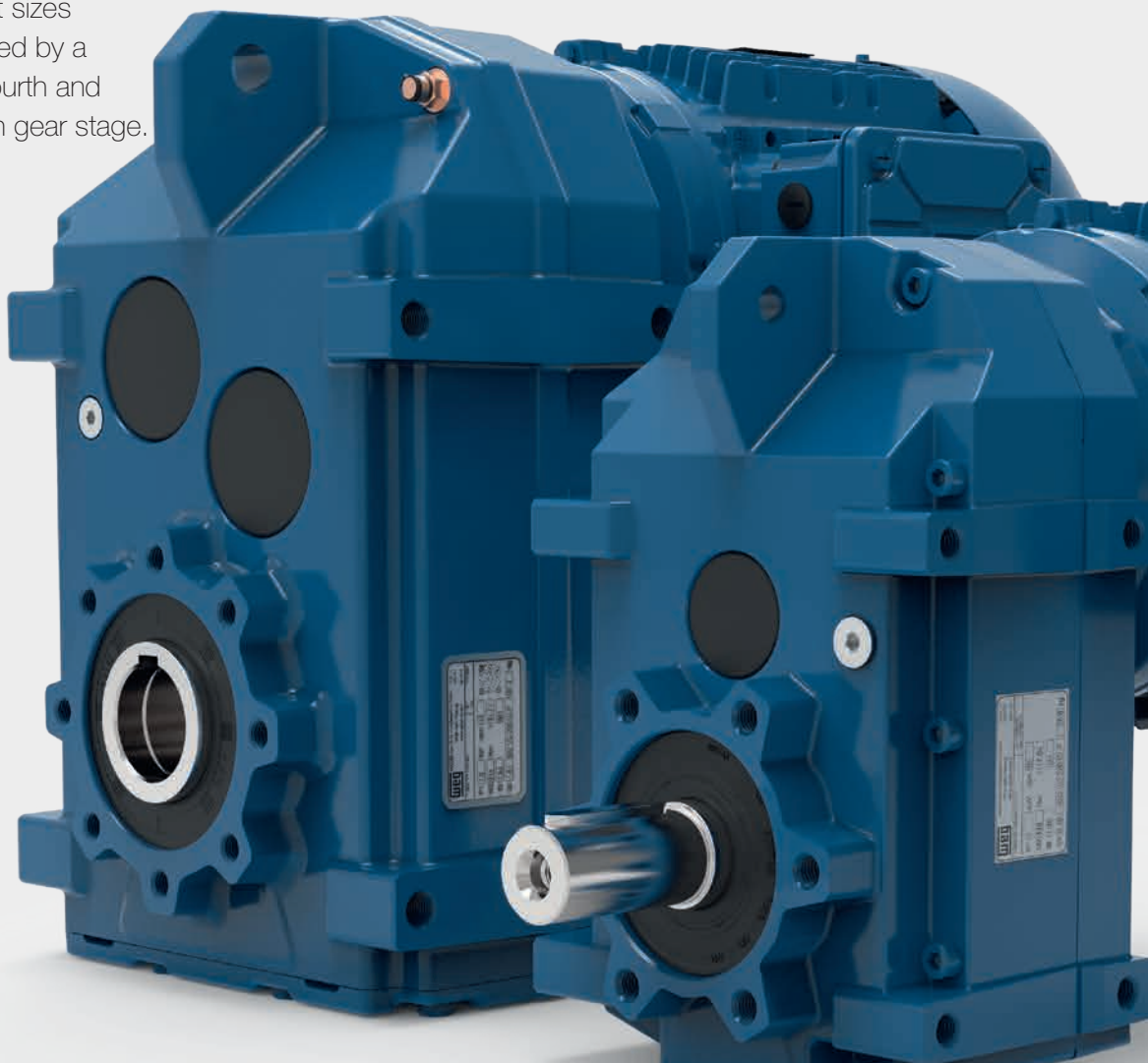

Technical data

	Nominal torque [Nm]	Number of stages	Ratio range	Speed range at 1400 rpm 50 Hz [rpm]	Power range 50Hz [kW]	Output shaft/ Ø hollow shaft [mm]	Output flange IEC [mm]	Housing material
F02	130	2	3.93 - 97.85	14 - 356	0.12 - 1.5	25 x 50 / 25	160	Aluminium
F03	220	2	3.85 - 70.17	20 - 364	0.12 - 3	25 x 50 / 30	160	
F04	400	2 / 3	4.26 - 422.98	3 - 328	0.12 - 3	30 x 60 / 35	200	
F05	600	2 / 3	4.98 - 487.67	3 - 281	0.12 - 9.2	35 x 70 / 40	250	
F06	820	2 / 3	4.41 - 412.64	3 - 317	0.12 - 15	40 x 80 / 40	250	Cast iron
F07	1500	2 / 3	4.29 - 385.37	4 - 327	0.12 - 15	50 x 100 / 50	300	
F08	3000	2 / 3 / 4	4.09 - 3836.13	0.4 - 327	0.12 - 22	60 x 120 / 60	350	
F09	4500	2 / 3 / 4	4.16 - 3086.96	0.5 - 337	0.12 - 37	70 x 140 / 70	450	
F10	8000	2 / 3 / 4	4.38 - 2276.77	0.6 - 320	0.12 - 75	90 x 170 / 90	450	
F12	13000	2 / 3 / 4	4.64 - 2307.03	0.6 - 302	0.12 - 90	110 x 210 / 100	550	
F15	18000	2 / 3 / 4 / 5	5.84 - 24805.81	0.1 - 240	0.12 - 110	120 x 210 / 120	660	

Design versions

Hollow shaft

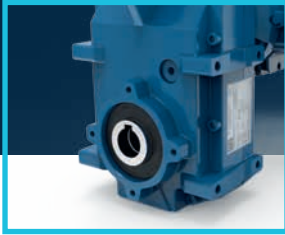

Output shaft

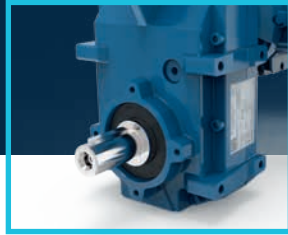

Flange

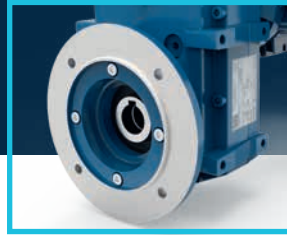

Shrink disc

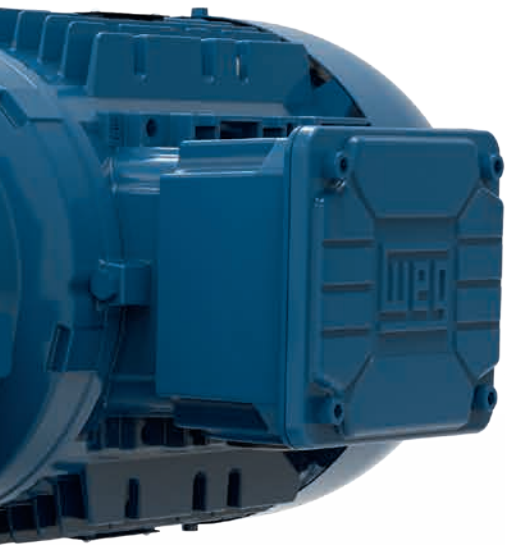
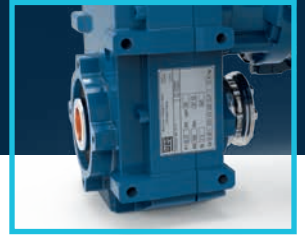

Standard mounting dimensions

Taking the most significant standard mounting dimensions on the market into account, the design allows for the easy integration of WG20 geared motors into almost any existing application.

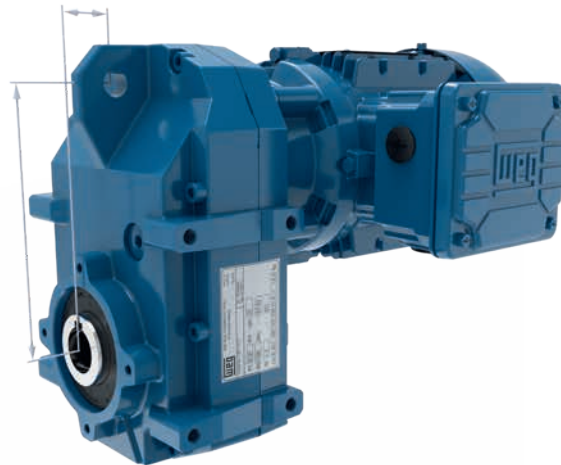

Typical areas of application

Machines for waste disposal and recycling, roller conveyors and laminating machines, machinery for timber processing companies, agitators, mixing equipment, stacking equipment, separators, screw conveyors, travel drives for cranes, welding equipment and surface aerators.

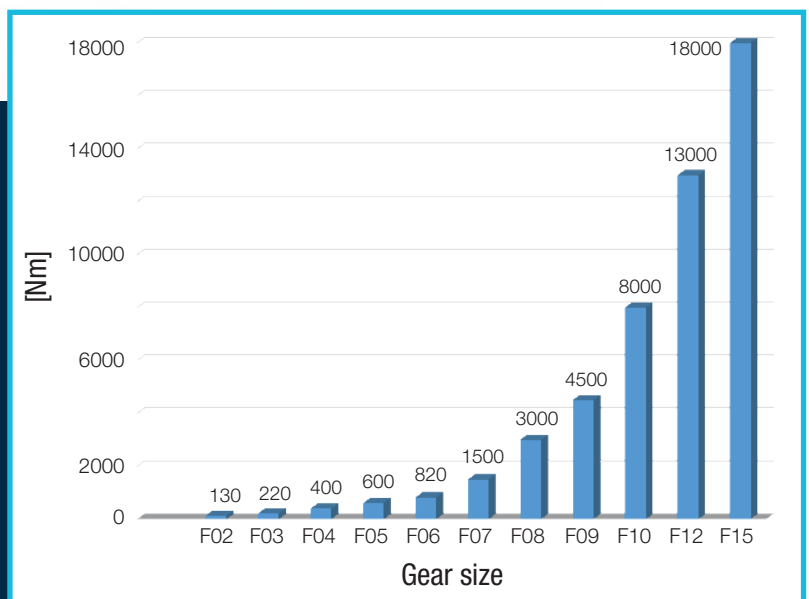

Helical bevel geared motors K

Helical bevel gear units are suitable for a multitude of applications. The two-stage basic design is extended by a third gear stage upward of 200 Nm, a fourth upward of 3000 Nm and a fifth at 18000 Nm. K gear units can also be equipped with a hollow shaft, output shaft, shrink disc, torque arm and mounting flange.

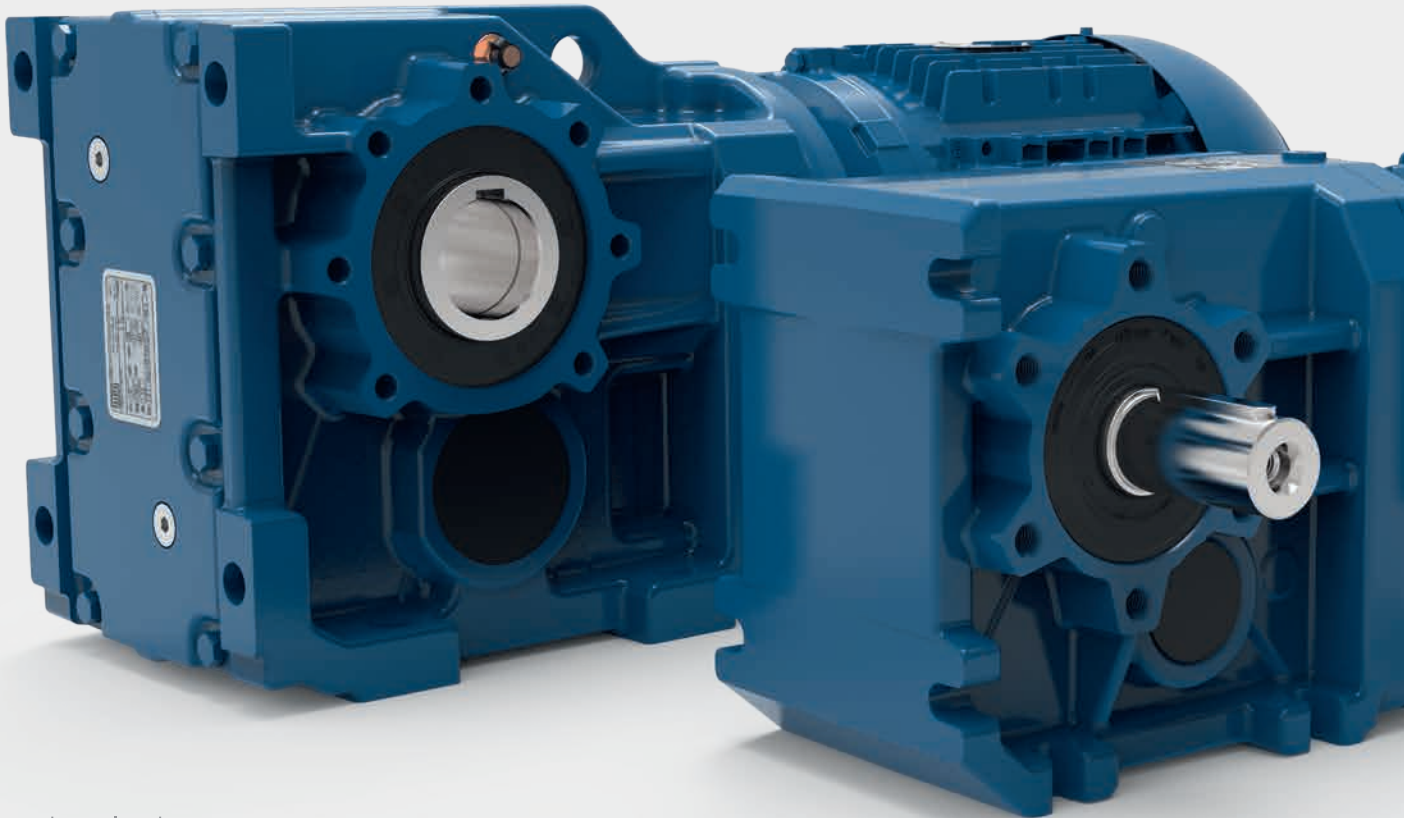

Technical data

	Nominal torque [Nm]	Number of stages	Ratio range	Speed range at 1400 rpm 50 Hz [rpm]	Power range 50Hz [kW]	Output shaft/ Ø hollow shaft [mm]	Output flange IEC [mm]	Housing material
K02	110	2	3.82 - 68.88	20 - 367	0.12 - 1.5	20 x 40 25 x 50 / 25	160	Aluminium
K03	200	3	4.17 - 217.88	6 - 336	0.12 - 3	25 x 50 / 30	160	
K04	400	3	4.87 - 277.79	5 - 287	0.12 - 4	30 x 60 / 35	200	
K05	600	3	4.27 - 245.7	5 - 328	0.12 - 9.2	35 x 70 / 40	250	
K06	820	3	4.94 - 198	7 - 283	0.12 - 9.2	40 x 80 / 40	250	Cast iron
K07	1550	3	7.91 - 256.14	6 - 177	0.12 - 15	50 x 100 / 50	300	
K08	3000	3 / 4	7.45 - 2205.52	0.6 - 188	0.12 - 22	60 x 120 / 60	350	
K09	4500	3 / 4	6.94 - 1810.95	0.8 - 202	0.12 - 37	70 x 140 / 70	450	
K10	8000	3 / 4	6.64 - 1301.54	1.1 - 211	0.12 - 55	90 x 170 / 90	450	
K12	13000	3 / 4	6.60 - 1579.81	0.9 - 212	0.12 - 75	110 x 210 / 100	550	
K15	18000	3 / 4 / 5	8.61 - 14005.40	0.1 - 163	0.12 - 110	120 x 210 / 120	660	

Design versions

Hollow shaft

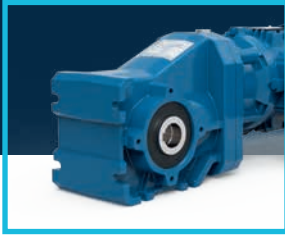

Output shaft

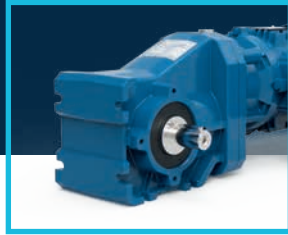

Flange

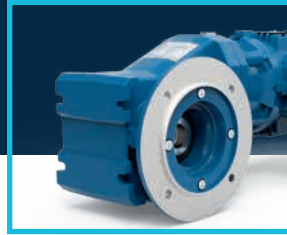

Shrink disc and torque arm

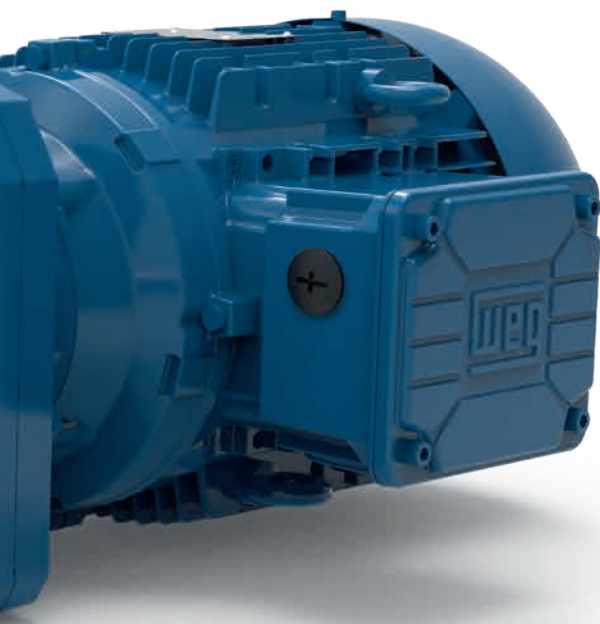

Standard mounting dimensions

Taking the most significant standard mounting dimensions on the market into account, the design allows for easy integration of WG20 geared motors into almost any existing application.

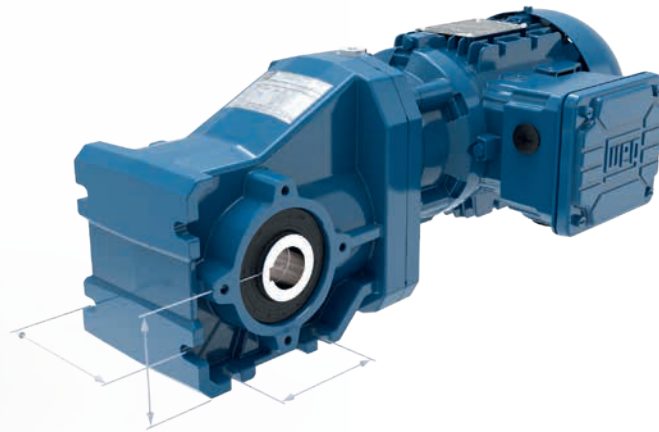

Typical areas of application

Roller tables and laminating machines, agitators, winches, lifts, heavy duty conveyors for bulky goods, shredders, conveyor belts, baggage handling systems, scenery lifts for stage machinery, bulk material and unit conveyors, and concrete mixing plants.

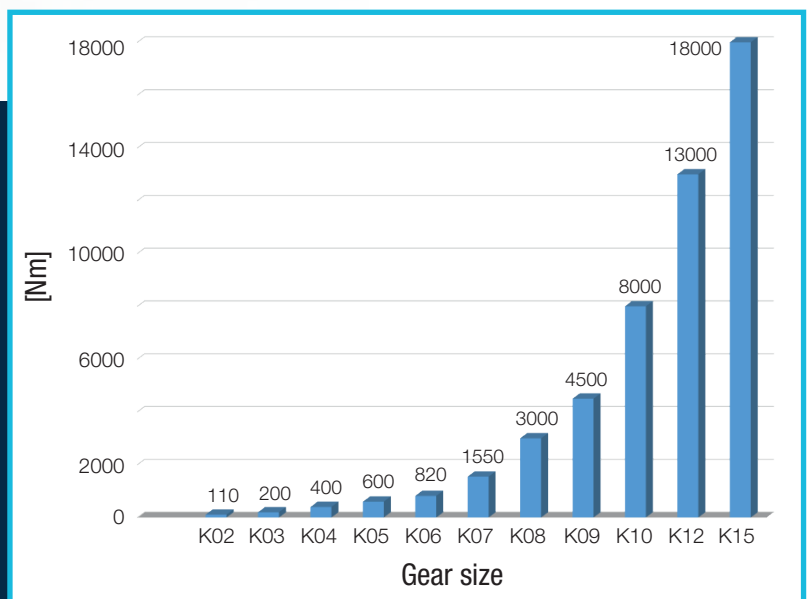

Helical worm geared motors S

WG20-S features a 2-stage design with significantly higher efficiency levels compared to mere worm gear units. The advantages of a right-angle gear unit in combination with numerous output and input variants provide a cost-effective alternative for the end user. Quiet running, overload capacity, compact design and a large speed/reduction range make these geared motors indispensable in modern drive concepts.

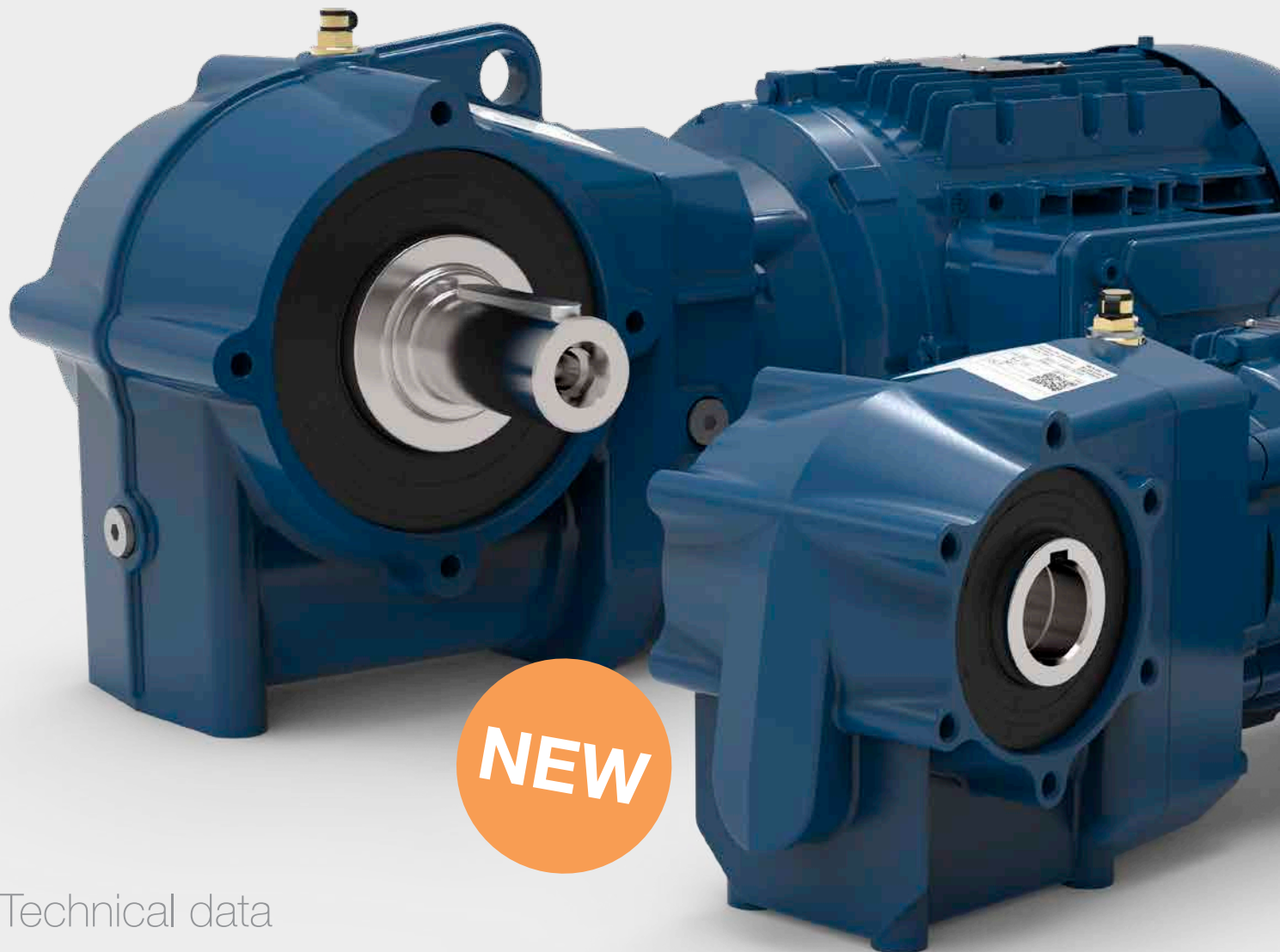

Technical data

	Nominal torque [Nm]	Number of stages	Ratio range	Speed range at 1400 rpm 50 Hz [rpm]	Power range 50Hz [kW]	Output shaft/ Ø hollow shaft [mm]	Output flange IEC [mm]	Housing material
S03	130	2	5.17 - 275.50	5 - 271	0.12 - 1.5	20 x 40 / 20	120 / 160	Aluminium
S04	230	2	6.92 - 323.70	4 - 202	0.12 - 2.2	25 x 50 / 25, 30	160	
S05	460	2	9.33 - 370.50	4 - 150	0.12 - 3.0	30 x 60 / 30, 35	200	
S06	1000	2	7.07 - 351.00	4 - 198	0.12 - 7.5	35 x 70 40 x 80 / 40, 45	200	Cast iron
S07	1600	2	9.68 - 460.00	3 - 145	0.12 - 9.2	45 x 90 50 x 100 / 50, 60	250	

Design versions

Hollow shaft

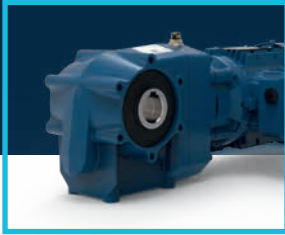

Output shaft

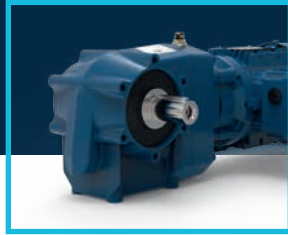

Flange

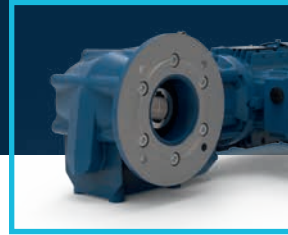

Shrink disc

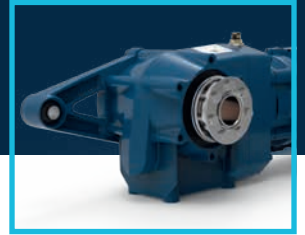

Standard mounting dimensions

Taking the most significant standard mounting dimensions on the market into account, the design allows for easy integration of WG20 geared motors into almost any existing application.

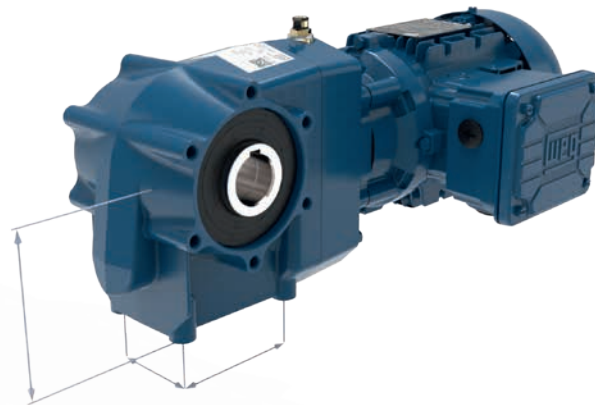
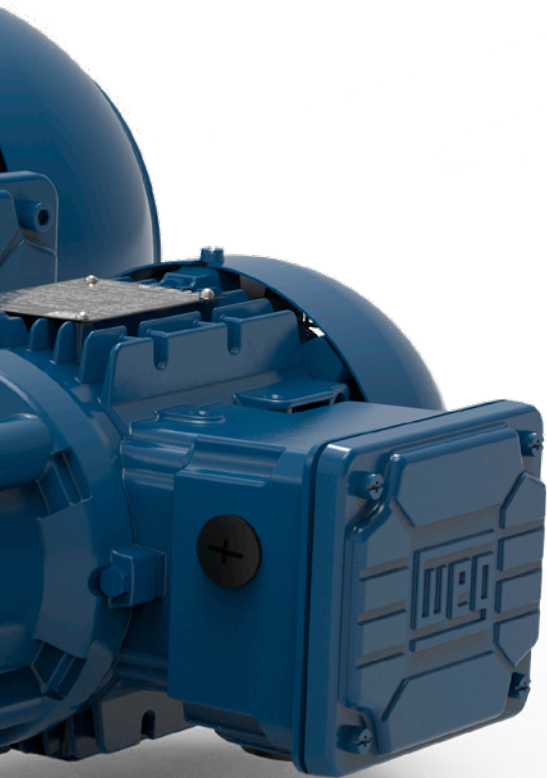

Typical areas of application

Small conveyor belts, airport logistics, screw conveyors for heating systems, bakery machines, beverage bottling plants, cable winch drives, travel drives and warehouse logistics.

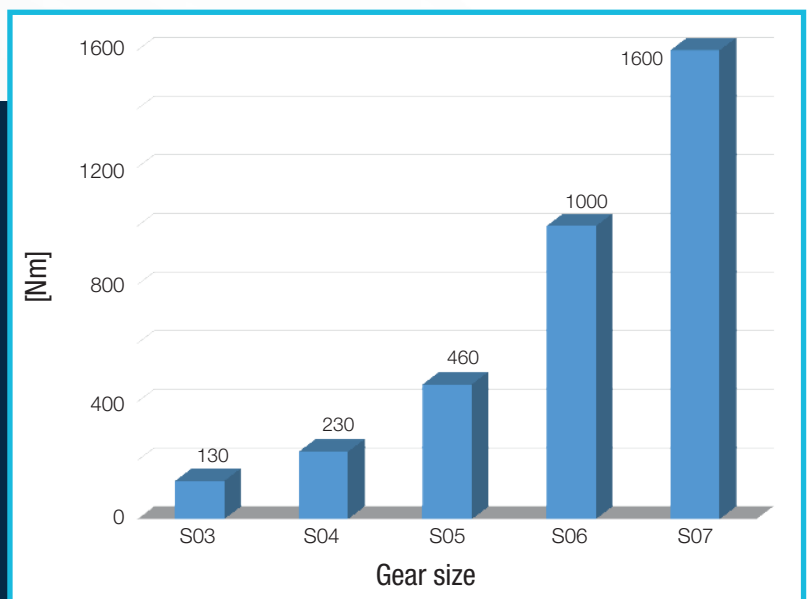

Modular INTEGRAL MOTOR in aluminium

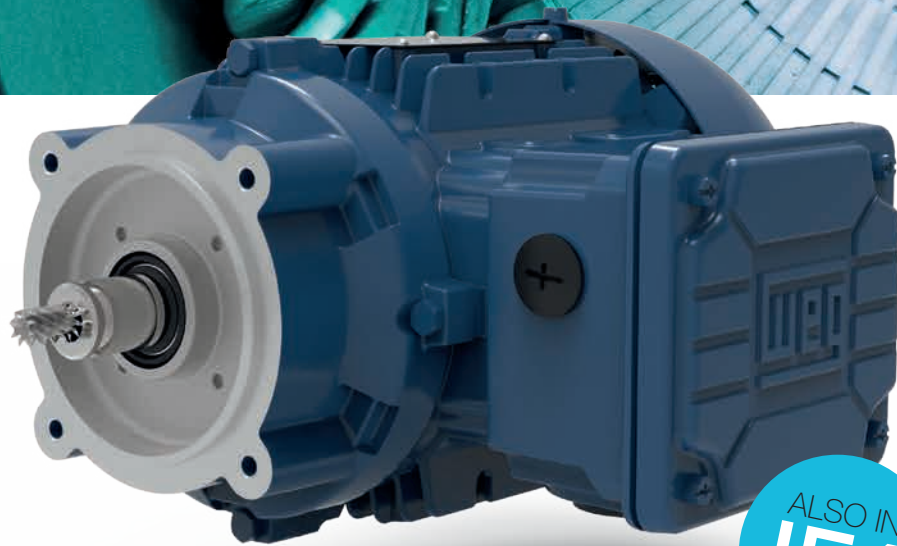

ALSO IN
IE4

Technical data (Standard)

	Multi-Voltage	EUSAS	
Power output	0.12 - 0.55 kW	0.75 - 9.2 kW	0.12 - 5.5 kW
IEC frame sizes	63 - 80	80 - 132	63 - 132
Number of poles	4 and 6	4 and 6	4
Efficiency class	IE3	IE3	IE4
Voltages	50 Hz: 230/400 V 60 Hz: 265/460 V	50 Hz: 230/400 V, 115/200 V 60 Hz: 265/460 V, 132/230 V	
		50 Hz: 400/690 V, 200/346 V 60 Hz: 460 V, 230/400 V	
Terminal board	6 bolts, 6 connection slots	9 bolts, 12 connection slots	
Inverter operation	up to 87 Hz	up to 100/120 Hz	
Thermal class	F		
Protection class	IP55		
Housing material	aluminium		
Thermal protection	bi-metal switch and thermistor protection PTC		
Certificates	CE, UL/CSA, EAC, CCC, UKCA	CE, UL/CSA, EAC, UKCA	

The latest generation of WEG asynchronous aluminium motors up to frame size 132 excels due to the user-friendly design up to efficiency class IE4 and the reliable quality in various industrial sectors.

The optimised design of the end shields and aluminium terminal box also results in a crucial reduction in weight.

Thanks to the special wide-range winding and nine-bolt terminal block, flexible use of the EUSAS motor is guaranteed anywhere in the world.

Modular INTEGRAL MOTOR in cast iron



ALSO IN
IE4

Technical data (Standard)

	EUSAS	
Power output	11 - 55 kW	7.5 - 110 kW
IEC frame sizes	160 - 225	132 - 280
Number of poles	4	4
Efficiency class	IE3	IE4
Voltages	50 Hz: 400/690 V, 200/346 V 60 Hz: 460 V, 230/400 V	
Terminal board	9 bolts, 12 connection slots	
Inverter operation	up to 100/120 Hz	
Thermal class	F	
Protection class	IP55	
Housing material	cast iron	
Thermal protection	thermistor protection PTC	
Certificates	CE, UL/CSA, EAC, UKCA	

The newly developed asynchronous integral motors in frame sizes 132 to 280 are members of the latest generation of the W22 motor family.

Due to their innovative design, these motors guarantee maximum value to the user and perform with highest efficiency and reliability.

The three-phase motors with a power output of 7.5 to 110 kW are available up to energy efficiency class IE4, they can be mains operated and are certified for use in all major markets worldwide.

Motor features

EUSAS: 100 Hz characteristic - double the power

EUSAS modular motors from 0.12 to 110 kW are perfect for operation with electronic speed control. The 87/100/120 Hz voltage/frequency characteristic allows them to be operated in frequency inverter mode even without special windings. This allows the nominal output to be doubled without losing torque.

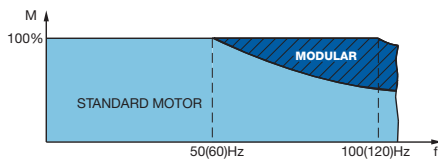

Rated (nominal) torque to double rated (nominal) speed

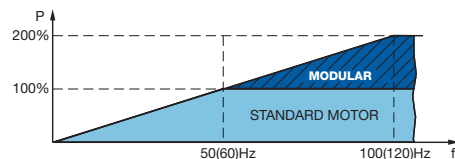

Double rated (nominal) power at twice the rated (nominal) speed

SIMPLY switch over for WORLDWIDE use

The special wide-range winding of the motor enables selection of up to four different voltage levels (star, delta, double star, and double delta) by means of twelve connection slots on the 9-bolt terminal block.

This allows modular motors to be used with almost any mains voltage and frequencies worldwide. Furthermore, the terminal box dimensions have been changed for easier accessibility.

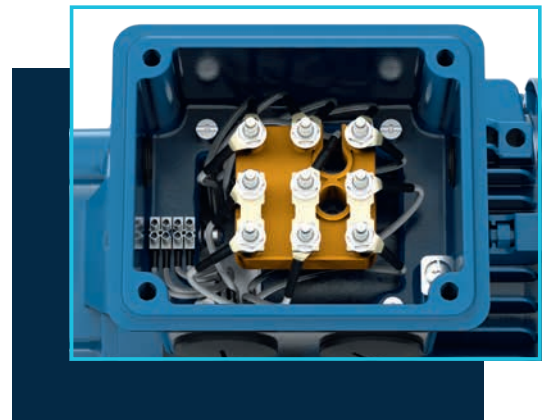

MOTOR MODULES for aluminium and cast iron motors

The particular advantage of the modular motor range is the facility to add system kits to the standard model, allowing a multitude of useful modules to be adapted to the customer's requirements.

Available motor modules include single and double brake systems, ventilation systems, extended terminal box systems, encoder systems (inside and outside the fan cover), back stops, protection caps, and hand wheels.

Spring loaded brake

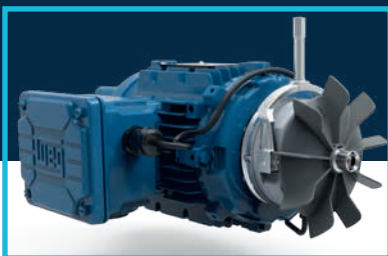

Forced ventilation

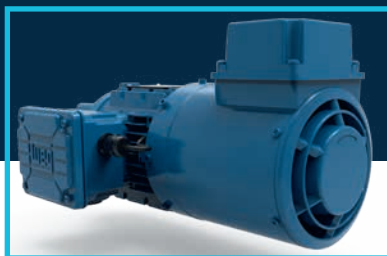

Incremental encoder (forced ventilation)

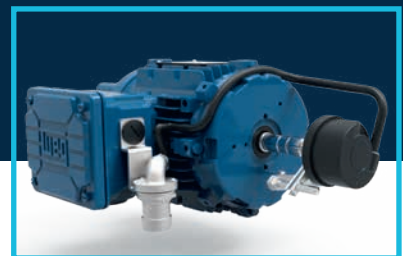

GEARED MOTORS for hazardous areas

The operation of machinery in areas with explosive air/gas or air/dust mixtures requires special measures. The European Directive 2014/34/EU specifies the minimum demands that must be met for electrical and mechanical equipment, such as gear units, in order to ensure safe operation.

WG20 gear units and geared motors meet all requirements of Directive 2014/34/EU for safe operation in ZONES 1 + 21 and ZONES 2 + 22.

Zone 2/22: Area in which an explosive atmosphere is unlikely to occur and only for a short period of time

Zone 1/21: Area in which an explosive atmosphere may appear occasionally during normal operation

Zone 0/20: Area in which an explosive atmosphere occurs continuously, for long periods or frequently
(not applicable for geared motors)

WG20 geared motor
for application in zones 1 + 21



WG20 geared motor
for application in zones 2 + 22



GEAR UNITS for a variety of motors

Even though our integral motors with top efficiency and power and wide voltage range are ideally suited for most applications, the operation of WG20 gear units is certainly also possible with other WEG motors, as well as third-party and special motors on customer request.

Adapters for IEC OR NEMA MOTORS

Standard motors according to DIN EN 50347 IM B5 or according to NEMA C-FACE can be mounted with suitable adapters. Depending on the size, the design is either a one-piece plug-in or a two-piece coupling adapter.

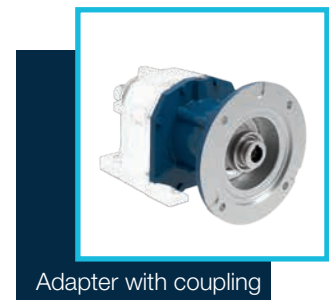

Adapters for SERVO MOTORS

Servo motors from a wide range of manufacturers can be mounted on WG20 gear units using SERVO adapters. The connection is made via flexible servo couplings and is suitable for both smooth shafts and motor shafts with key.



GEARED MOTORS with decentralised VSD

The greatest possible freedom and flexibility with a highly efficient and compact drive - that is the promise of combining a WG20 geared motor with the decentralised frequency inverter MW500. Compared to central solutions, a decentralised drive system can be networked more easily with common bus systems and can be installed and maintained faster with shorter cable lengths. This saves both costs and energy.



PANEL
not required



Reduced
INSTALLATION COSTS



Space saving and
flexible SOLUTION

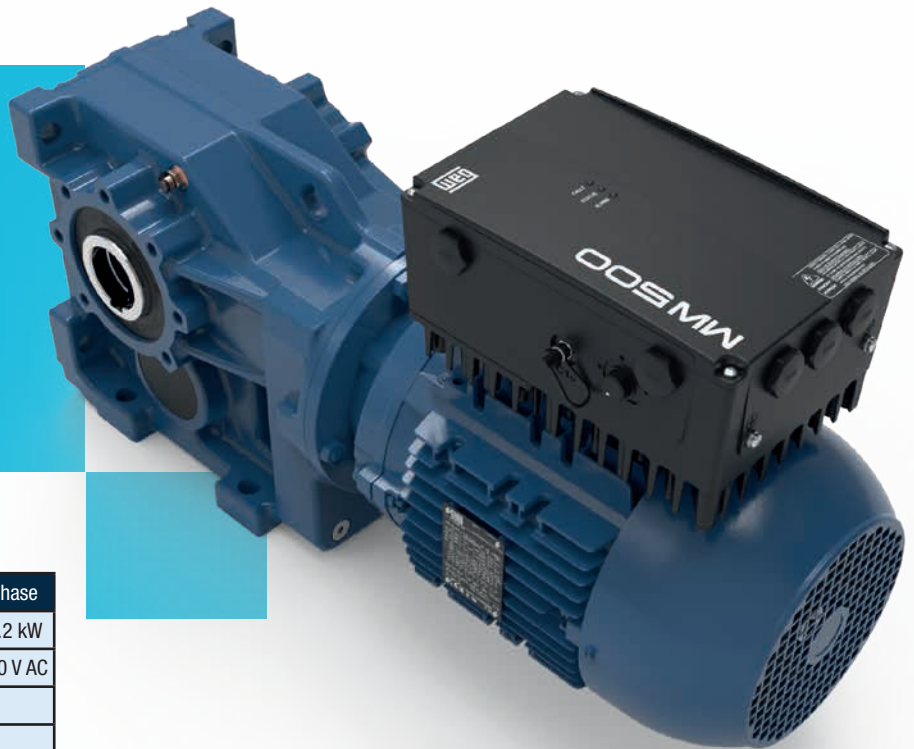

Technical data

	Single-phase	Three-phase
Power range	0.12 - 1.5 kW	0.12 - 9.2 kW
Voltage range	200 - 240 V AC	380 - 480 V AC
Protection class	IP66 / NEMA 4X	
Control	V/f speed regulation vector control (VW)	
Dynamic braking	available as standard	
Connectivity	Profibus-DP, CANOpen, DeviceNet, EtherNet/IP, Modbus-TCP, Profinet-IO, USB, RS485, RS232, Bluetooth	
Optional accessory	RFI filter, disconnect switch, remote HMI, flash memory module, I/O extension modules	

Special connector IP66
for HMI or external sensor



LED indicators and
optional disconnect switch



Built-in
analogue potentiometer



FULL-SERVICE PROVIDER for drive solutions

WEG's product portfolio includes all important components for the industrial drive train. From gear units and motors to control units, all elements are perfectly harmonised and guarantee maximum efficiency in operation and high-quality workmanship.



CFW300:
0.12 to 7.5 kW

CFW500:
0.12 to 110 kW

CFW900:
1.1 to 132 kW

Variable speed drives CFW series

Frequency inverters from WEG are the perfect addition for controlling the speed of three-phase asynchronous motors.

The range extends from the compact microdrive and the robust all-rounder to inverters that have been developed for special applications, e.g. pumps, HVAC, lifts, etc.

Extensive equipment and additional modules for communication interfaces offer flexibility and the use of state-of-the-art technology.

Soft starters SSW series

The soft starters from WEG enable smooth acceleration and deceleration of electric motors. The combination of innovation and functionality makes them the right choice for use in industrial applications.



SSW900:
2.2 to 1000 kW; 220 to 690 VAC; 10 to 1400 A; removable HMI, pump control, fire mode, various communication protocols; ...

For the entire WEG product portfolio, please visit the website www.weg.net.



Digital solutions WEG Scan

With the digital monitoring and diagnostic devices, operating data of motors and gear units can be called up at the touch of a button. Possible damage can be detected early and unplanned downtimes can be avoided.

Industrial gear units WG50

Although WG20 covers a very wide range of applications, there are areas of use that require even higher torques. With the WG50 industrial gear unit series, WEG offers parallel shaft and helical bevel gear units with a torque of up to 178,000 Nm.

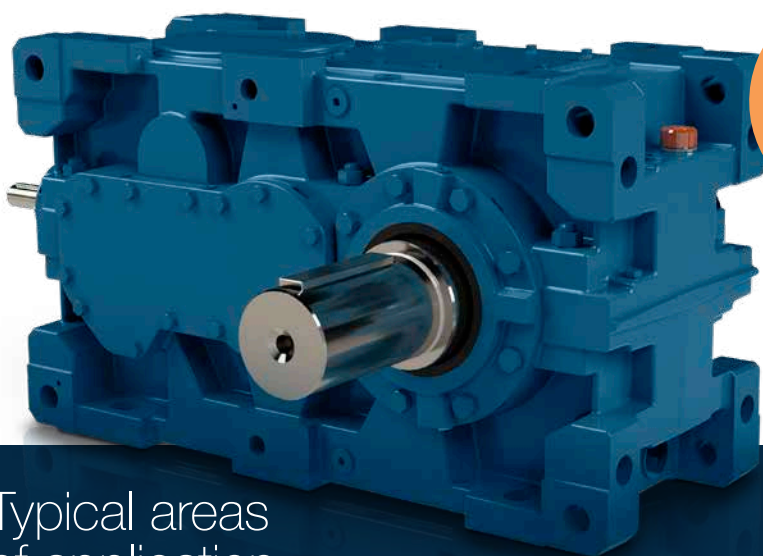

Technical data

	WG50
Nominal torque	22,000 - 178,000 Nm
Number of stages	2 / 3 / 4
Ratio range	6.3 - 450
Speed range	3.1 - 222 rpm
Housing material	Spheroidal graphite cast iron
Optional accessory	Back stop Torque arm Cooling

Typical areas of application

Mining, steel industry, conveyor technology, environmental technology, wood and paper industry, food industry and cooling towers.



www.cat4cad.com

Easy product selection

The “cat4CAD®” product configuration tool makes it easy to interactively select products. Comprehensive wizards, user-friendly navigation and many other extra features allow quick configuration of the required drive.

ADVANTAGES

- Extensive product library
- Fast configuration of motors and geared motors
- Creation of project files with comprehensive technical documentation
- Easy modification of generated product data by means of the project file
- Quick request times

FEATURES

- The entire menu is available in many languages.
- To-scale 2D/3D drawings and PDF and DXF dimension sheet drawings of the previously selected drive.
- The 2D/3D data can be exported for use in standard CAD programs.
- Comprehensive technical data sheets of the configured gear unit and motor at the click of a button.
- The project file allows complete management of previously selected drives on one screen.
At the click of a button one can save or print this project file, create PDF and DXF dimension drawings and send enquiries directly to our sales team.

SEE THE ONLINE VERSION AT www.cat4cad.com

DOWNLOAD THE OFFLINE VERSION AT www.weg-gears.net

Avantages for you



A geared motor **FOR THE WHOLE WORLD**

- Standard mounting dimensions
- Can be switched to different voltages around the world
- Certifications for international markets



Sophisticated design **FOR MORE EFFICIENCY**

- Wide speed range
- High efficiency
- Low noise levels
- Optimised oil fill quantity
- Maintenance-free and lubricated for life up to 600 Nm
- High quality components and equipment
- Motors to efficiency class IE4



Comprehensive equipment **FOR MORE FLEXIBILITY**

- Can be extended by different motor modules
- Temperature monitoring without added costs
- Protection degree IP55 for the standard design
- Switchover to 100/120 Hz characteristic in frequency inverter operation



The optimal program **FOR LOWER COSTS**

- Reduction in operating costs for plant operators
- Standard mounting dimensions enable easy interchangeability without system conversion
- Low maintenance costs
- Flexibility and savings for purchasing, technology and warehousing



One company **FOR MORE SERVICE**

- Complete drive applications from WEG
- Global WEG branches and sales partners
- Short delivery times
- Innovative product configuration tool

The scope of solutions of the WEG Group is not limited to the products and solutions presented in this brochure.

**Please contact us
to learn more about our entire portfolio.**

**For our worldwide
operations visit our websites**



www.weg.net
www.weg-gears.net



 +43 (0)2633 404-0

 info-at@weg.net

 WEG Gear Systems GmbH
Wöllersdorfer Strasse 68 - 2753 Markt Piesting
Austria